



CSP2NX6D+QH6D Actual size

\*QH6D Ratchet head  
(Shown attached to the wrench is removable and sold separately)



Preset Type Interchangeable Head

Torque Wrenches

# CSP6D

Series

Coordinating Interchangeable Heads

# QH6D

# SH6D

- Ideal for work in tight spaces
- QH6D and SH6D Interchangeable heads were designed specifically for the CSP6D series torque wrench with compact slimline dimensions
- Features torque set completion with distinctive feel and click
- CSP2NX6D: 0.4~2N·m  
CSP5NX6D: 1~5N·m



## Feature

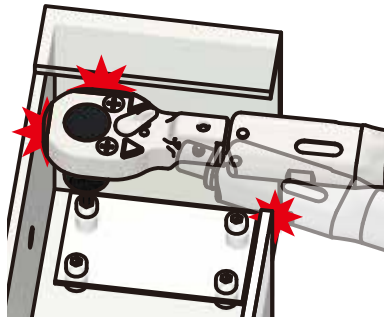

Long swing ratchet

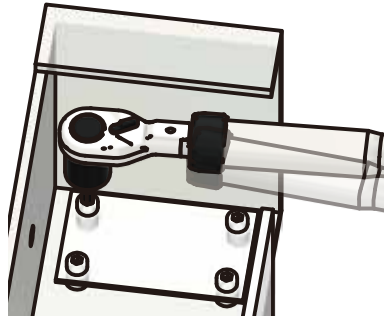

### Interference Reduction

The slimmer body, smaller head, and halved swing angle drastically reduce the interference area of the tool.

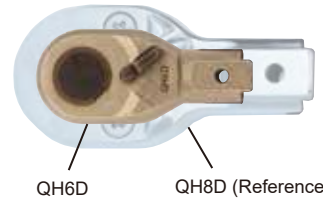

QH6D

QH8D (Reference)

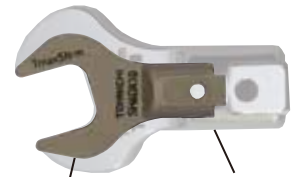

SH6DX10

SH8DX10 (Reference)



### Clear Click Sound

The improved internal link design creates a more distinctive click making it easier to confirm torque completion.



### 48 Teeth Gear (QH6D)

The 48-tooth gear achieves a swing angle (7.5°) that is half of the conventional gear, preventing ratcheting loss and enabling quick tightening operations.



### Precision Tightening Work

Knurling is effectively applied to visually and sensibly guide the user to the correct grip position.

\*Correct grip position leads to accurate torque output.

## CSP6D Series



CSP2NX6D

- Interchangeable, preset type torque wrench
- Use after torque setting
- Specify set torque value and torque unit when required initial torque setting

Accuracy  $\pm 3\%$

Model	Torque Range			Force P [N]	Weight [kg]
	[N·m]	[kgf·cm]	[lbf·in]		
CSP2NX6D	0.4 ~ 2	4.0 ~ 20	3.5 ~ 17.7	17.5	0.06
CSP5NX6D	1 ~ 5	10 ~ 50	8.8 ~ 44.2	44	

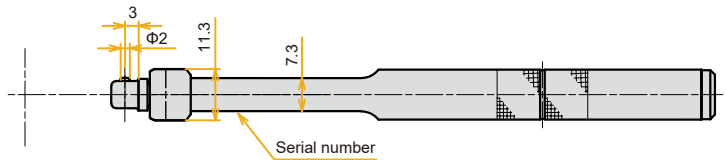
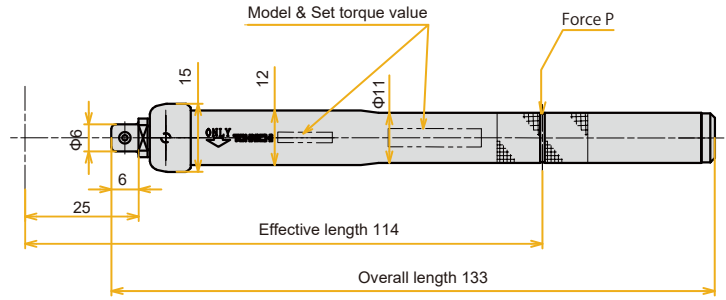

### Optional accessories

Adjusting Tool

- Special tool for torque change.
- \*A torque wrench tester is necessary for torque setting.

Part No.
931



## Interchangeable Head for CSP6D Series

### QH6D Ratchet head

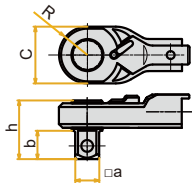

Head Size	Model	R (mm)	C (mm)	h (mm)	Sq. Drive □ a (mm)	b (mm)
	QH6D	7.5	15	15.5	6.35	7.5

- QH6D ratchet teeth 48 increments 7.5° swing angle improves workability (QH8D ratchet teeth in 24-tooth increments, swing angle of 15°)
- Improved accessibility makes it possible to accurately apply torque in narrow spaces.

### SH6D Open Spanner Head

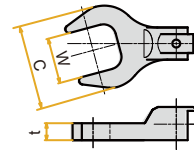

Head Size	Model (Body x AF size) (mm)	Outside Width C (mm)	Thickness t (mm)	Allowable Torque (N·m)
	SH6D× 5.5	13		1.5
	SH6D× 6	15	3	2.5
	SH6D× 7	17		3.5
	SH6D× 8	18		
	SH6D×10	20	4.5	
	SH6D×11	21		
	SH6D×12	22		
	SH6D×13	23		5
	SH6D×14	24		
	SH6D×16	26	5	
	SH6D×17	27		
SH6D×19	29			

## Related New Product

### Small Capacity Digital Torque Wrench Tester

- A wide range Tester that can calibrate all signal type torque wrenches of 10 Nm or less.
- For sensitive small-capacity torque measurement, developed loading mechanism with the square drive rotates.

Accuracy  $\pm 1\% + 1$  digit

Model	Torque Range [N·m]		Inlet Drive [mm]	Weight [kg]
	Min. ~ Max.	1 Digit		
DOT10N4-G	0.2 ~ 10	0.001	6.35	7

\* Multiple torque unit model: Metric unit: 2~100kgf·cm, 1 digit 0.01 kgf·cm, American unit 2~88lbf·in, 1 digit 0.01 lbf·in are selectable





■ TOHNICHI MFG.CO.,LTD.

E-mail: [overseas@tohnichi.co.jp](mailto:overseas@tohnichi.co.jp)

Website: <http://www.global-tohnichi.com>

■ N.V. TOHNICHI EUROPE S.A.

■ TOHNICHI AMERICA CORP.

■ TOHNICHI SHANGHAI MFG. CO., LTD.

东仁扭矩仪器（上海）有限公司

■ Tohnichi Asia Technical Support Office (TATSO)

● Designs and specifications are subject to change without notice.  
● All rights reserved. No reproduction or republication without written permission.  
● ©Tohnichi Mfg. Co., Ltd. All Rights Reserved.